

**nutribullet.**  
PORTABLE BLENDER



**User guide.**

# Important safeguards.

When operating your nutribullet® Portable Blender, remember: **SAFETY COMES FIRST.**

**Warning!** To avoid the risk of serious injury or damage, carefully read all instructions before operating your nutribullet® Portable Blender. Basic safety precautions, including the following important information, should always be observed when using any electrical appliance.

If you let anyone else use your nutribullet® Portable Blender, ensure they understand the health and safety information in this User Guide and any additional safety or usage instructions. Each person using a device should completely read the User Guide to become familiar with the safe operation of the unit.

## ! Save these instructions! ! FOR HOUSEHOLD USE ONLY

### HEAT AND PRESSURE SAFETY

**! WARNING! DO NOT BLEND HOT, WARM, CARBONATED, OR EFFERVESCENT INGREDIENTS.**

- Such use may over-pressurize the nutribullet® Cup, causing the Cup and Motor Base to separate while operating. This may result in bodily injury from expelling hot content or exposed blades.
- Only blend room-temperature or refrigerated ingredients (21°C/70°F or cooler).
- Carbonated and effervescent ingredients (e.g., soda, baking powder, baking soda, yeast, some batters, cake mix, dry ice, or other things that become bubbly) release gasses that increase pressure within the Cup when blending. Some protein powders include effervescent ingredients. Always check the ingredients of all supplements before blending. **Always check all ingredients before blending.**

**! WARNING! DO NOT BLEND CONTENTS FOR MORE THAN ONE MINUTE. DO NOT RUN CONSECUTIVE BLENDING CYCLES THAT EXCEED ONE MINUTE TOTAL.**

- Blending causes ingredients to heat up, which builds pressure in the Cup over time. Continuous blending for more than one minute may cause the Cup to separate, exposing the blade or expelling heated contents and causing injury.

**! WARNING! DO NOT LEAVE BLENDED FOODS IN A SEALED CUP FOR PROLONGED PERIODS OF TIME.**

- Blended mixtures can spoil and ferment, increasing pressure when left inside the Cup. This may cause the Cup to separate if open from the Motor Base, which may result in bodily injury from expelling hot contents or exposed blades.
- Only access the blended contents through the Sip and Carry Lid by carefully opening the Lid after blending.

### CUP CAUTION

- If the Cup is hot or warm to the touch, the contents may be **HEATED** and **PRESSURIZED**. If this happens, take these steps:
- **LEAVE ALONE, DO NOT OPEN.** Leave the Cup where it is and do not touch it or allow others to touch it. **NEVER** attempt to separate the Cup from the Motor Base as this can result in bodily injury.
- Do not blend again.
- Allow the Cup to cool for at least 30 minutes. If still warm, allow for more cooling time.
- Once cool to the touch, slowly open the Lid, while pointing away from your face and body. Pour contents out into a separate vessel.

### CUP SAFETY

Proper Cup use is important to safely operate your nutribullet® Portable Blender. Using the Cup inconsistent with these instructions may result in bodily injury, property damage, or damage to your unit.

- **ALWAYS** ensure the Cup is securely locked on the Motor Base before blending. The motor will not turn on unless the Cup is situated in the locked position.
- **ONLY** operate the unit with the Lid cover in place.
- **DO NOT** exceed the MAX line. Exceeding the MAX line can result in leakage or stop page of the blade.
- **DO NOT** remove the Cup or Lid while the unit is in operation.
- **DO NOT** overfill the Cup with ice as it may stop the blades from turning resulting in damage to the unit or injury. Always use sufficient amount of liquid before blending.
- Do not use the Cup if you detect cracking, cloudiness, or other damage.

- Only order replacement parts from **nutribullet.com** or by contacting Customer Service.

### BLADE SAFETY

**! WARNING! BLADES ARE SHARP! HANDLE WITH CARE TO AVOID BODILY INJURY.**

- Do not touch the sharp edges of the blades.
- Do not place hands or fingers near the blades when attaching the Cup to the Motor Base.
- Handle with care when washing the blade by hand.
- Always make sure the power is off and the charger is unplugged when assembling, disassembling, or cleaning the blade or Motor Base.
- Do not store the Motor Base with the blades exposed. Always attach the Cup to the Motor Base.

**! WARNING! NEVER PUT YOUR HANDS INSIDE THE CUP OR NEAR THE BLADE WHEN THE UNIT IS RUNNING.**

- Do not remove the Cup or Lid until the blades have completely stopped. Blades can still activate when the Lid is removed. Not following these instructions may result in bodily injury, property damage, or damage to your unit.

### BLADE CARE AND CAUTION

**! WARNING! DISCONTINUE USE IF THE BLADE IS BENT OR DAMAGED.**

- Routinely inspect the blades for damage, and if detected, contact Customer Service for blade removal and replacement.
- Remove all utensils and non-food items from Cup before operating as it may result in bodily injury or damage to the blade and unit.

- Do not blend stone fruit in this appliance unless pits/seeds have been removed. Hard ingredients may damage the blade.
- The blades may stop turning if the Cup is overfilled. If this occurs, please refer to the **Errors** section in this User Guide.

## SURROUNDING SAFETY

**! WARNING! DO NOT USE YOUR NUTRIBULLET® PORTABLE BLENDER WHILE DRIVING, OPERATING MACHINERY, CYCLING, WALKING, OR ENGAGING IN OTHER ACTIVITIES THAT REQUIRE YOUR UNDIVIDED ATTENTION.**

- Do not expose your nutribullet® Portable Blender to extreme temperatures, as this can cause damage to the batteries, seals, and other parts of the device.
- Do not place your nutribullet® Portable Blender on uneven or unstable surfaces.
- Do not dry your device with a hair dryer, clothes dryer, conventional oven, or microwave oven. If your device becomes wet, gently wipe the exterior with a clean, dry cloth.
- Do not use your device near water or in wet, rainy, or snowy conditions.
- Do not use your device near an open flame or other heat source; near areas of excessive dirt, dust, oil, or chemicals; or in direct sunlight.
- Do not leave your nutribullet® Portable Blender inside your vehicle, especially in the summer or winter. Prolonged exposure to extreme temperatures can cause the batteries to leak, rupture, or explode.

## GENERAL USE AND SAFETY

**! WARNING! FAILURE TO FOLLOW ALL INSTRUCTIONS REGARDING YOUR NUTRIBULLET® PORTABLE BLENDER MAY RESULT IN SERIOUS**

### PERSONAL INJURY, DEATH, OR PROPERTY DAMAGE.

- This appliance is not intended for use by persons (including children) with reduced physical, sensory, or mental capabilities, or lack of experience and knowledge, unless they are closely supervised and instructed concerning use of the appliance by a person responsible for their safety. Close supervision is necessary when any appliance is used by or near children. Children should be supervised to ensure that they do not play with the appliance.
- Periodically inspect your nutribullet® Portable Blender components for damage or wear that may impair proper functioning or create a safety hazard.
- Be aware of possible hazards when charging, using, or storing your nutribullet® Portable Blender.
- Do not use this blender for anything other its intended use.
- Never operate your nutribullet® Portable Blender if the Cup is empty.
- Do not attempt to defeat any safety interlock mechanisms.
- Do not insert any object other than the appropriate charger into the USB-C port. Do not allow dust to accumulate inside the port.
- Do not crush, drop, or damage the Motor Base. Do not operate if the Motor Base is damaged in any manner. Contact Customer Service for assistance at **1 (800) 523-5993**.
- Use only nutribullet® attachments/accessories specifically designed for your nutribullet® Portable Blender. Always use genuine nutribullet® replacement parts and accessories. Aftermarket parts are not made to nutribullet® specifications and may damage your unit or cause serious injury.
- The use of attachments including canning jars, is not recommended by the manufacturer may cause a risk or injury to persons.
- Do not attempt to clean the Motor

Base by immersing in water or other cleaning liquids. Only gently wipe and dry with a clean cloth.

- Only the Cup and Lid are dishwasher safe on Top Rack without the heat or sanitize cycle. **NEVER PLACE THE MOTOR BASE IN THE DISHWASHER.**

## ELECTRICAL SAFETY

**! WARNING! MODIFICATION, IMPROPER USE, AND FAILURE TO FOLLOW INSTRUCTIONS CAN INCREASE THE RISK OF SERIOUS PERSONAL INJURY, DEATH, OR PROPERTY DAMAGE.**

- Use only UL-listed USB sources to charge this device or a Listed/Certified ITE Power Supply or Listed Class 2 Power designed for use with power sources rated 100V AC to 240V AC at 50Hz to 60Hz. The USB charger must be listed Class 2 power supply or certified ITE power supply, rated output 5V 2A MAX. **Do not use unapproved sources.**
- To avoid the risk of electrical shock, fire or bodily injury, **DO NOT** charge or handle the unit if it is wet, or in an area that could get wet, or handle with wet hands.
- Do not use in wet conditions, or immerse the cord, plug, or Motor Base in water or other liquids.
- Do not operate with a damaged cable, Power Supply Unit/Charger, or appliance malfunction, or if or if the Motor Base has been dropped or damaged in any manner. Contact Customer Service for assistance at **1 (800) 523-5993**.
- Always **POWER OFF** and **UNPLUG** the nutribullet® Portable Blender when it is not in use, and **BEFORE** assembling, disassembling, changing accessories, or cleaning.
- Do not charge your device around flammable materials, on your bed or couch, or on top of any type of paper.

- Only charge your device with the power cord that came with it. Using incompatible parts or aftermarket parts may damage your nutribullet® Portable Blender or create safety hazards that may cause personal injury or damage.

## POWER SUPPLY SAFETY

**! WARNING! ALWAYS SELECT AND USE YOUR DEVICE'S APPROPRIATE AC POWER SUPPLY.**

- Failure to take the following precautions can result in serious personal injury, death from electric shock or fire, or damage to your device.
- Only use a Power Supply Unit (e.g., charger, charging brick) and power cord specifically for your country's voltage.
- Do not use a wall charger with a voltage converter device or adapter.
- Do not use non-standard power sources, such as generators or inverters. Use only AC power provided by a standard wall outlet.
- Do not use a rapid charger or higher wattage charger. Use only AC power provided by a standard wall outlet or automobile lighter port. Never have the unit plugged in the automobile lighter port when starting your car to prevent possible power surge and shorting out of the unit.
- Confirm that your electrical outlet provides the type of power indicated for your nutribullet® Portable Blender (in terms of voltage [V] and frequency [Hz]). If you are unsure of the type of power supplied to your home, consult a qualified electrician.
- Do not overload your wall outlet, extension cord, power strip, or other electrical receptacles. Confirm that they are rated to handle the total current (in amps) drawn by your device (as indicated on your Power Supply Unit) and any other devices using the same circuit.

- For the Power Supply Unit where the AC prongs may be folded for storage, ensure the prongs are fully extended before plugging into an outlet.
- Never use a Power Supply Unit/Charger that is damaged, has been dropped, or received a sharp impact.
- Do not charge in an area of extreme heat or cold.
- Always unplug the Power Supply Unit/Charger when not in use.

## CABLE AND CORD SAFETY

**! WARNING! USE ONLY THE POWER CORD THAT CAME WITH YOUR NUTRIBULLET® PORTABLE BLENDER TO CHARGE.**

- Inspect your power cords and cables regularly.
- Exposed device cables and cords pose a potential tripping hazard. Arrange all cables and cords so that people and pets are not likely to trip over or accidentally pull on them as they move around or walk through the area.
- Do not wrap or wind the power cord too tight when storing nor bend or crease the power cord when using.
- When positioning your device or Power Supply Unit/Charger, ensure that the cords are not bent sharply and that the connectors are not pushed against a wall or hard surface.
- Do not allow pets or children to bite or chew on cables and cords.
- When disconnecting the power cord, pull on the plug—do not pull on the cord.
- Do not let the charging cable touch hot surfaces or any extreme heat source, or become knotted, tangled, or frayed.
- Do not grab or carry your device by the charging cable or cord.
- Do not let the charging cable hang over the edge of a table or counter.

## BATTERY SAFETY

Your nutribullet® Portable Blender contains rechargeable lithium-ion batteries. **The batteries are not replaceable and must be recycled or disposed of properly.** Opening and/or repairing or attempting to replace the batteries to your device can cause electric shock, device damage, fire, and personal injury, or property damage.

- This product contains lithium ion batteries. Dispose of your Motor Base properly. Improper disposal may result in injury, death, or property damage as a result of battery fluid leakage, fire, overheating, or explosion. Lithium ion batteries contain elements that may pose health risks to individuals if they are allowed to leach into the groundwater supply. Disposing of these batteries in standard household waste may be illegal in some countries. Please consult your local jurisdiction for proper disposal.
- Contact your local recycling or hazardous waste disposal centers in your area for proper disposal instructions.
- Do not expose the Motor Base containing the battery pack to fire or excessive heat. Exposure to fire or temperatures above 265°F/130°C may damage the batteries and cause an explosion.
- Do not recharge your nutribullet® Portable Blender near a fire, heat source, or in extremely hot conditions.
- Recommended storage and ambient charging temperature: 50°F–104°F (10°C–40°C).
- Do not use your unit in any area with a potentially explosive atmosphere (e.g., fueling areas or fuel service stations, below decks on boats or other vessels, fuel and/or chemical transfer and storage facilities, and areas where flammable chemicals

or particles, such as grain dust or metal powders have collected in the air). In such areas, sparks can occur and cause an explosion or fire.

- Do not use your unit if the Motor Base is overheated, has an odor, leaks, is bulging, or changes in color/shape. Leaks from battery cells can occur under extreme conditions. Battery fluid is corrosive and may be toxic. It can cause burns and may be harmful or fatal if swallowed. Turn off immediately, discontinue use, and contact Customer Service for assistance at **1 (800) 523-5993**.
- **Avoid contact with battery fluid. If a battery leaks:**
  - Keep the leaked fluid from touching your skin, eyes, clothes, or other surfaces. If the battery fluid contacts your skin, eyes, or clothes, immediately rinse the affected area with water and contact your doctor or other medical providers as appropriate.
- Do not use your unit in any area with a potentially explosive atmosphere, such as a cabinet above your oven or stove, near a radiator or heater, or in any area exposed to direct sunlight.
- Do not incinerate the Motor Base. The batteries can explode.

**! Save these instructions!**

To view these instructions online or in other languages, visit [nutribullet.com](http://nutribullet.com).

# Contents.



- 10 What's included**
- 11 Assembly guide**
- 12 LED light indicator status**
  - 12 Charging**
  - 13 Settings**
  - 14 Errors**
- 16 Using the nutribullet® Portable Blender**
- 18 Care and maintenance**
  - 18 Replacement parts**
- 19 nutribullet® Portable Blender One-Year Limited Warranty**
- 22 Product registration**

Thank you for purchasing the nutribullet® Portable Blender.

# What's included.

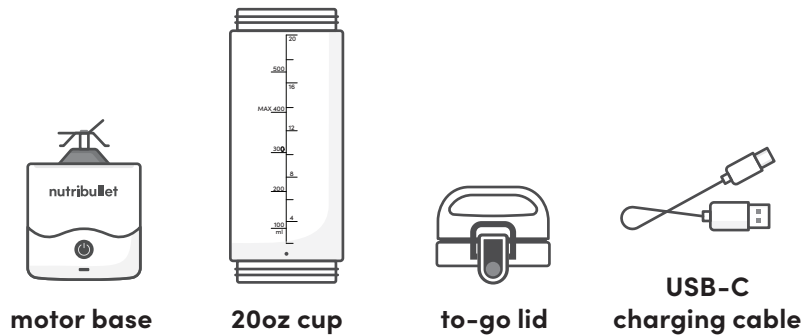

Product configurations may vary. To see our full list of nutribullet® accessories please visit [nutribullet.com](http://nutribullet.com).

## Before first use.

### CLEAN UNIT:

See **Care and Maintenance** section on page 18.

### CHARGE UNIT:

Plug the smaller end of the included **USB-C Cable** into the slot right below the **Power** button (on the front of the **Motor Base**) and the larger end of the cable into its power source (plug adapter, computer, etc.).

- We recommend fully charging the unit before using it for the first time. It takes 60-90 minutes to reach a full charge.

Please see **LED Status Light Indicator** section on pages 12-14.

**! WARNING! Do not charge if your unit or the USB-C port is wet to avoid risk of fire or bodily injury.**

# Assembly guide.

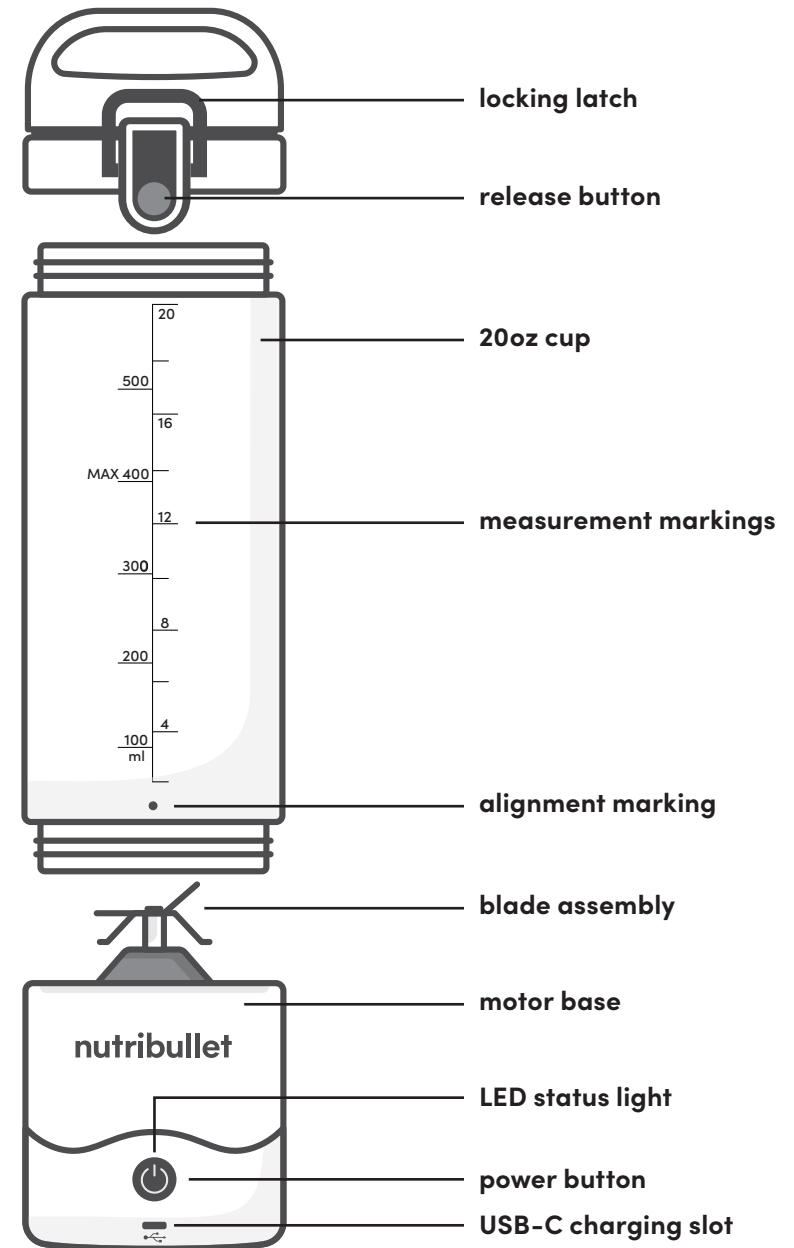

# LED light indicator status.

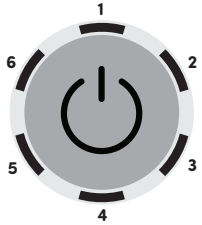

The nutribullet® Portable Blender's indicator has six LED light bars that appear red or blue according to the unit's operational status. See below for details.

## Charging.



**No power**  
All LEDs off.



**Charging**  
LEDs blink to solid blue in clockwise order.



**Low power**  
LED 1 flashes red.



**Fully charged**  
All LEDs light solid blue.

## Settings.

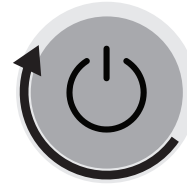

### Wake

Press button once to wake up your blender. When the ring is solid blue, you are ready to blend.



### Blend mode

Blue LEDs circulate clockwise. Press the **Power** button to start a 20-second cycle.

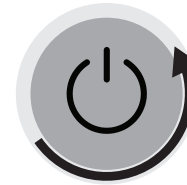

### Sleep

After 2 minutes of inactivity, your blender will automatically go into sleep mode. When the ring is off, the blender is off.



### Battery check

Press and hold the **Power** button for 2 seconds to check the battery level remaining.

## Errors.

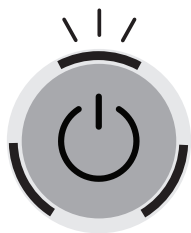

### Too many blends

Light ring will flash red, alternating between top and bottom LEDs.

**Solution:** Pause activity and allow blender to cool before next use. Don't exceed 9 blending cycles within 6 minutes.



### Overheat

Light ring will turn red.

**Solution:** Pause activity and allow blender to cool before next use.



### General error

Light ring will flash red.

### Troubleshooting:

Make sure your Cup is secured and aligned properly.

If the blade is blocked, then try the following:

- Add more liquid to the Cup and try blending again.
- Shake blender or turn upside down to remove blockage.
- Turn unit off and remove blockage from blade using a utensil.

## ⚠ WARNING!

**Before first use, review all warnings and caution statements in the important safeguards section (pages 2-7).**

**ALWAYS** make sure your blender is clean and charged before use.

Fully charge your blender before first use. The charging port is located under the light indicator of the **Motor Base**. (See the assembly section on page 11 for reference.)

**DON'T** run your nutribullet® Portable Blender when empty.

**DON'T** microwave any nutribullet® accessories.

**DON'T** leave your nutribullet® Portable Blender unattended when in use.

**DON'T** charge your nutribullet® Portable Blender if your **USB-C Cable** is wet.

**DON'T** use hot or warm ingredients in your blending cup. Heated ingredients can cause pressure to build up in the sealed cup that may expel hot contents upon opening, potentially causing personal injury or property damage.

**NEVER** run the nutribullet® Portable Blender for more than one minute at a time, as it can cause permanent damage to the motor. If the motor stops working, pause activity and allow the blender to cool. Your nutribullet® Portable Blender has an internal thermal breaker that shuts the unit off when it overheats. Letting the thermal breaker cool down should allow it to reset.

**ALWAYS** inspect your blade. During the warranty period, contact Customer Service before removing the blade for safety instructions and replacement.



# Using the nutriBullet® Portable Blender.

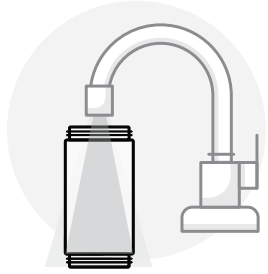

**1** Clean **Blending Cups** with hot, soapy water before use.

**NOTE:** You can also clean your blender by adding cold water and a drop of soap to the **Cup** and blending for one cycle.



**2** Twist off the **Lid** and add your ingredients.

**WARNING!** For best performance, do not exceed the **MAX** line, do not overfill, and use sufficient liquid ingredients.

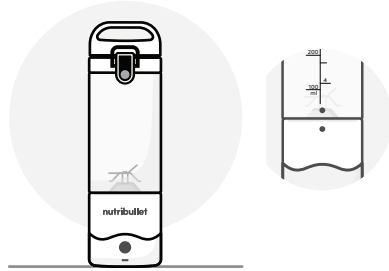

**3** Place the **nutriBullet® Portable Blender** on a clean, dry, and level surface.

**NOTE:** Ensure the **Cup** is positioned properly by aligning the two dots located on the **Cup** and **Motor Base**.

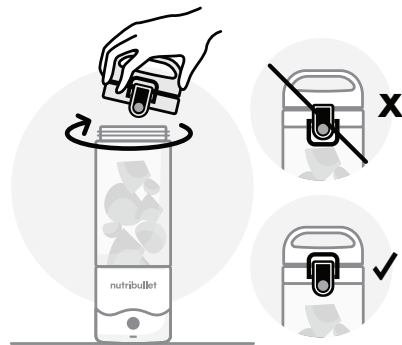

**4** Twist the **Lid** back onto the **Cup**.

**NOTE:** Make sure the **Lid Latch** is upright in the locked position.



**5** Wake up your blender by pressing the **Power** button once. Wait about 1 second for the light animation to complete.

**NOTE:** After 2 minutes of inactivity, your blender will automatically go into **Sleep Mode**. This prevents accidental blends and preserves battery life.



**6** Once your blender is awake, press the **Power** button again to start a 20-second blend cycle.

If you want to **Pulse** your ingredients or stop your blend cycle early, press the **Power** button again to stop.

**WARNING!** Do not blend for longer than one minute to avoid excessive heat and pressure build-up. For repeat cycle, carefully open the container to release any built-up pressure before blending again.

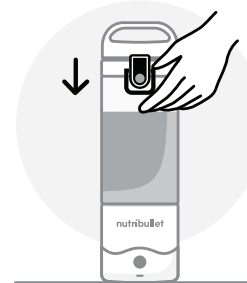

**7** Once blending is complete, flip the latch down to unlock the **Lid Latch**.

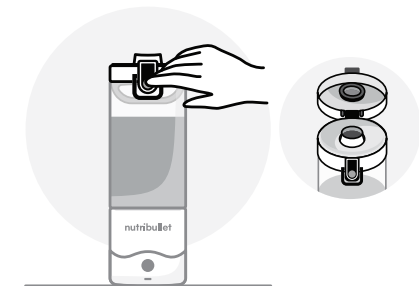

**8** Press the button on the **Lid** to open and reveal the spout. Enjoy!

# Care & maintenance.

## STEP 1:

Always make sure the nutribullet® Portable Blender is turned off after each use.

## STEP 2:

Hand-wash the Cup and Lid with warm, soapy water and rinse clean:

**NOTE:** The motor base is **NOT** dishwasher safe. However, the Cup and Lid can be washed in the top rack of your dishwasher without the heat or sanitize cycle.

## STEP 3:

Gently rinse the blade assembly and wipe with a damp sponge or cloth:

**NOTE:** Never submerge or run the Motor Base under water.

 **WARNING! Do not touch blades! They are very sharp.**

 **WARNING! Do not blend hot or warm liquids in the 20oz Cup.**

 **WARNING! Never submerge the Motor Base into water or any other liquid.**

## STEP 4:

Always store your nutribullet® Portable Blender in a safe place, upright with the Cup attached, so that the blades are covered and not exposed. Do not stack any objects on top of the unit while storing.

---

## Replacement parts.

To order additional parts and accessories, please visit our website at [nutribullet.com/shop/accessories](https://nutribullet.com/shop/accessories) or feel free to contact Customer Service: **1 (800) 523-5993**.

# nutribullet® Portable Blender one-year limited warranty.

## LIMITED WARRANTY FOR NUTRIBULLET® PORTABLE BLENDER:

### The nutribullet® Portable Blender limited warranty obligations are confined to the terms set forth below:

Capital Brands Distribution, LLC, warrants the nutribullet® Portable Blender against defects in materials and workmanship for a period of one year from date of delivery of the product to the consumer. This limited warranty is valid only in the country in which the product is purchased and comes with the product at no additional charge, however shipping and processing fees will be incurred for returns, replacements and or refunds.

If a defect exists, and nutribullet® Portable Blender is obligated under this limited warranty, at its option, Capital Brands Distribution, LLC will (1) repair the product at no charge, using new or refurbished replacement parts, (2) exchange the product with a product that is new or that

has been manufactured from new or serviceable used parts and is at least functionally equivalent to the original product, or (3) refund the purchase price of the product. A replacement product assumes the remaining warranty of the original product. A repaired product has a one-year warranty from the date of repair. When a product or part is exchanged, any replacement item becomes your property and the replaced item becomes Capital Brands Distribution, LLC 's property.

When a refund is given, your product becomes Capital Brands Distribution, LLC 's property.

## OBTAINING WARRANTY SERVICE:

For limited warranty service, simply call our customer service department **1 (800) 523-5993** or contact us via email from our website at [nutribullet.com](https://nutribullet.com), simply click the Customer Service link and

fill out the customer service form, and we will be glad to help you. When you contact our customer service department you will be asked for your name, address, telephone number and to provide proof of the original purchase (receipt) containing a description of the product(s), purchase date, and the appropriate nutribullet® Portable Blender bar code(s). Before you send your product for limited warranty service please make sure to keep a copy of all relevant documents for your files (receipt, etc.). It is always recommended to purchase product insurance and tracking services when sending your product for service. Remember, shipping and processing fees will be incurred and are not covered by the one-year limited warranty.

#### **EXCLUSIONS & LIMITATIONS:**

This nutribullet® Portable Blender One-Year Limited Warranty applies only to nutribullet® Portable Blender products distributed by or for Capital Brands Distribution, LLC that can be identified by the “nutribullet® Portable Blender” trademark, trade name, logo affixed to it and bar code. nutribullet® Portable Blender’s One-Year Limited Warranty does not apply to any other products that may

appear to be authentic, but were not distributed or sold by **nutribullet.com**.

Normal wear and tear is not covered by this limited warranty. This limited warranty applies to consumer use only, and is void when the product is used in a commercial or institutional setting.

This limited warranty gives you specific legal rights, and you may also have other rights which vary from state to state. Capital Brands Distribution, LLC is not liable for any damage to products not covered by this warranty (e.g., cups, book, User Guide).

This limited warranty does not apply: (a) to damage caused by accident, abuse, misuse, or misapplication; (b) to damage caused by improper maintenance (including unauthorized parts service); (c) to a product or a part that has been modified in any way; (d) if any nutribullet® Portable Blender bar code or trademark has been removed or defaced; and or (e) if the product has been used with an adapter/converter.

**THIS LIMITED WARRANTY AND THE REMEDIES SET FORTH ABOVE ARE EXCLUSIVE AND IN LIEU OF ALL OTHER WARRANTIES, REMEDIES AND CONDITIONS, WHETHER**

**ORAL OR WRITTEN, EXPRESS OR IMPLIED. CAPITAL BRANDS DISTRIBUTION, LLC SPECIFICALLY DISCLAIMS ANY AND ALL IMPLIED WARRANTIES, INCLUDING, WITHOUT LIMITATION, WARRANTIES OF MERCHANTABILITY AND FITNESS FOR A PARTICULAR PURPOSE.**

**IF CAPITAL BRANDS DISTRIBUTION, LLC CANNOT LAWFULLY DISCLAIM IMPLIED WARRANTIES UNDER THIS LIMITED WARRANTY, ALL SUCH WARRANTIES, INCLUDING WARRANTIES OF MERCHANTABILITY AND FITNESS FOR A PARTICULAR PURPOSE ARE LIMITED IN DURATION TO THE DURATION OF THIS LIMITED WARRANTY.**

No nutribullet® Portable Blender reseller, agent, or employee is authorized to make any modification to this warranty.

**CAPITAL BRANDS DISTRIBUTION, LLC IS NOT RESPONSIBLE FOR DIRECT, SPECIAL, INCIDENTAL OR CONSEQUENTIAL DAMAGES RESULTING FROM ANY BREACH OF WARRANTY OR CONDITION, OR UNDER ANY OTHER LEGAL THEORY, INCLUDING BUT NOT LIMITED TO LOST PROFITS, DOWNTIME, GOODWILL, DAMAGE TO OR REPLACEMENT OF EQUIPMENT AND PROPERTY. CAPITAL**

**BRANDS DISTRIBUTION, LLC SPECIFICALLY DOES NOT REPRESENT THAT IT WILL BE ABLE TO REPAIR ANY PRODUCT UNDER THIS LIMITED WARRANTY.**

Some states and provinces do not allow the exclusion or limitation of incidental or consequential damages or exclusions or limitations on the duration of implied warranties or conditions, so the above limitations or exclusions may not apply to you. This warranty gives you specific legal rights, and you may also have other rights that vary by state or province.

# Product registration.

Please visit [nutribullet.com/register](http://nutribullet.com/register) or call **1 (800) 523-5993** to register your new nutribullet® Portable Blender. You will be asked to enter the **Serial Number\*** of your product, along with the purchase date and place of purchase. **The information you submit is for product registration. Failure to complete product registration does not diminish your warranty rights.**

The registration will enable us to contact you in the unlikely event of a product safety notification. By registering your product, you acknowledge that you have read and understood the instructions for use, and warnings set forth in the accompanying instructions.

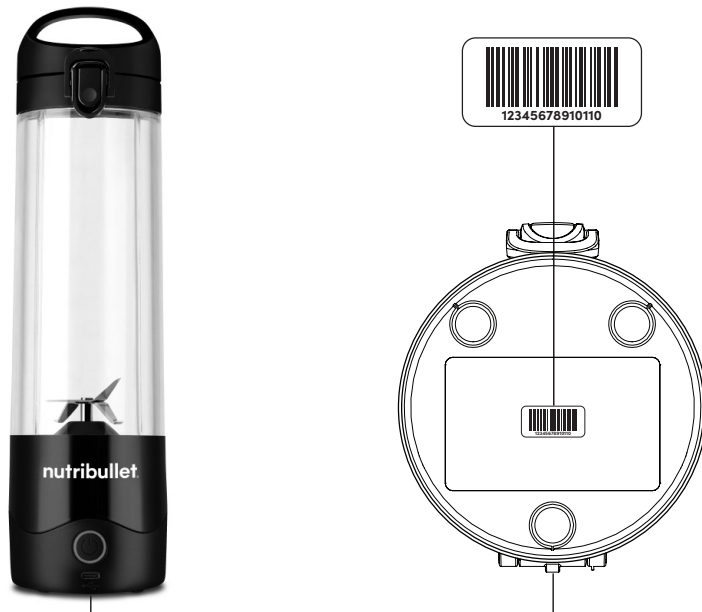

**\*To find the serial number, check under the Motor Base of the unit.**

**If you cannot find the serial number, call customer service for assistance.**

**Capital Brands Distribution, LLC | [nutribullet.com](http://nutribullet.com) | All rights reserved.**

nutribullet® Portable Blender is the trademark of CapBran Holdings, LLC registered in the U.S.A. and worldwide.

Illustrations may differ from the actual product. We are constantly striving to improve our products, therefore the specifications contained herein are subject to change without notice.

**240920\_NBPB50100**